

UGF8HT AND UGF8JT

ULTRAFAST SOFT RECOVERY RECTIFIER

Reverse Voltage - 500 to 600 Volts Forward Current - 8.0 Amperes

ITO-220AC

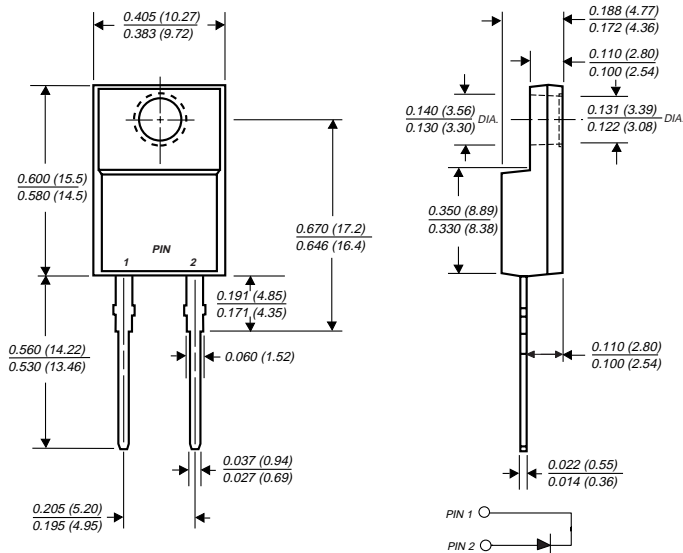

FEATURES

- ◆ Plastic package has Underwriters Laboratories Flammability Classification 94V-0
- ◆ Ideally suited for freewheeling diode power factor correction applications
- ◆ Soft recovery characteristics
- ◆ Excellent high temperature switching
- ◆ Planar technology
- ◆ Optimized to reduce switching losses
- ◆ High temperature soldering guaranteed: 250°C, 0.25" (6.35mm) from case for 10 seconds

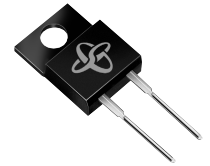

MECHANICAL DATA

Case: ITO-220AC molded plastic body

Terminals: Plated leads, solderable per MIL-STD-750, Method 2026

Polarity: As marked

Mounting Position: Any

Weight: 0.08 ounce, 2.24 grams

Mounting Torque: 5 in. - lbs. max.

MAXIMUM RATINGS AND ELECTRICAL CHARACTERISTICS

Ratings at 25°C ambient temperature unless otherwise specified.

	SYMBOLS	UGF8HT	UGF8JT	UNITS
Maximum repetitive peak reverse voltage	V_{RRM}	500	600	Volts
Working peak reverse voltage	V_{RWM}	400	480	Volts
Maximum RMS voltage	V_{RMS}	350	420	Volts
Maximum DC blocking voltage	V_{DC}	500	600	Volts
Maximum average forward rectified current at $T_C=100^\circ\text{C}$	$I_{(AV)}$	8.0		Amps
Peak forward surge current 8.3ms single half sine-wave superimposed on rated load (JEDEC Method)	I_{FSM}	100.0		Amps
Maximum instantaneous forward voltage at $I_F=8\text{A}$ (NOTE 1)	V_F	1.75 1.50		Volts
Maximum reverse leakage current at working peak reverse voltage	I_R	$T_C=25^\circ\text{C}$	30.0	μA
		$T_C=100^\circ\text{C}$	800.0	μA
		$T_C=125^\circ\text{C}$	4.0	mA
Maximum reverse recovery time at $I_F=0.5\text{A}$, $I_R=1.0\text{A}$, $I_{rr}=0.25\text{A}$	t_{rr}	25		ns
Reverse recovery time at $I_F=1.0\text{A}$, $di/dt=50\text{A}/\mu\text{s}$, $V_R=30\text{V}$, $I_{rr}=0.1 I_{RM}$	t_{rr}	Maximum	50	ns
		Typical	35	ns
Typical softness factor (t_b/t_a) $I_F=8.0\text{A}$, $di/dt=240\text{A}/\mu\text{s}$, $V_R=400\text{V}$, $I_{rr}=0.1 I_{RM}$	S	1.0		-
Maximum reverse recovery current at $I_F=8.0\text{A}$, $di/dt=64\text{A}/\mu\text{s}$, $V_R=400\text{V}$	I_{RM}	5.5		Amps
Typical reverse recovery current at $I_F=8.0\text{A}$, $di/dt=240\text{A}/\mu\text{s}$, $V_R=400\text{V}$	I_{RM}	10.0		Amps
Peak forward recovery time at $I_F=8\text{A}$, $di/dt=64\text{A}/\mu\text{s}$ measured at 1.1 V_F	t_{fr}	Maximum	500	ns
		Typical	250	ns
Typical thermal resistance from junction to case	$R_{\theta JC}$	5.0		$^\circ\text{C}/\text{W}$
Operating junction and storage temperature range	T_J, T_{STG}	-55 to +150		$^\circ\text{C}$

NOTE: (1) Pulse test: 300 μs pulse width, 1% duty cycle

NOTICE: Advanced product information is subject to change without notice

RATINGS AND CHARACTERISTIC CURVES UGF8HT AND UGF8JT

FIG. 1 - FORWARD CURRENT DERIVATIVE CURVE

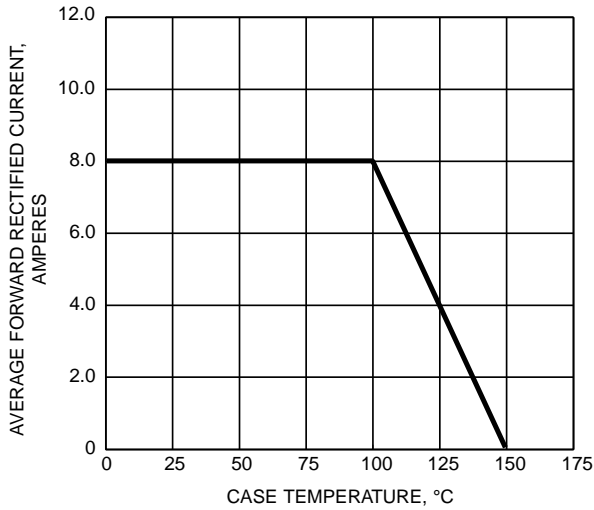

FIG. 2 - MAXIMUM NON-REPETITIVE PEAK FORWARD SURGE CURRENT

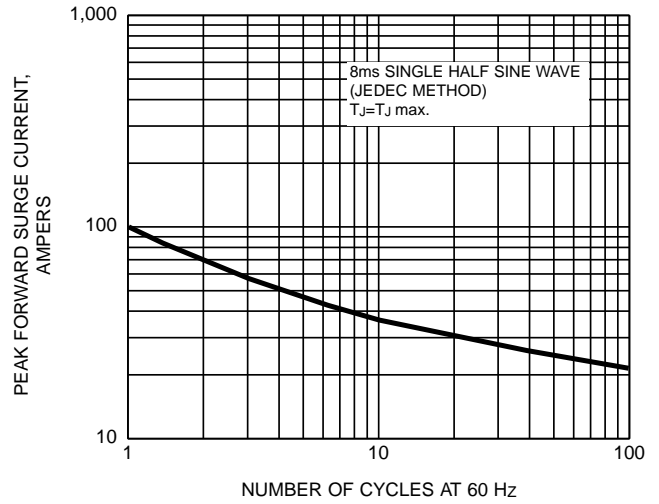

FIG. 3 - TYPICAL INSTANTANEOUS FORWARD CHARACTERISTICS

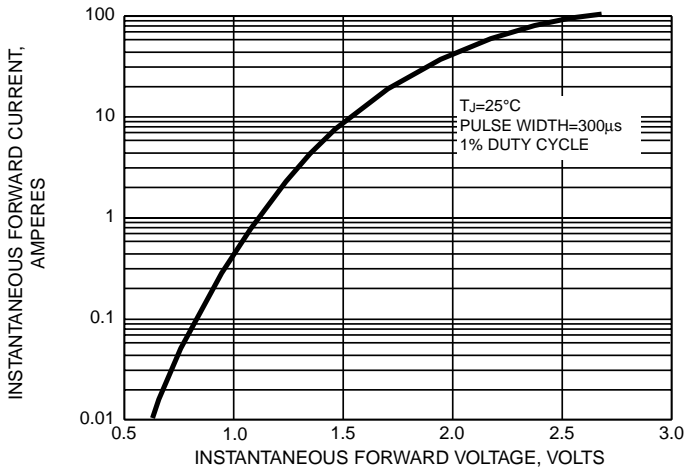

FIG. 4 - TYPICAL REVERSE CHARACTERISTICS

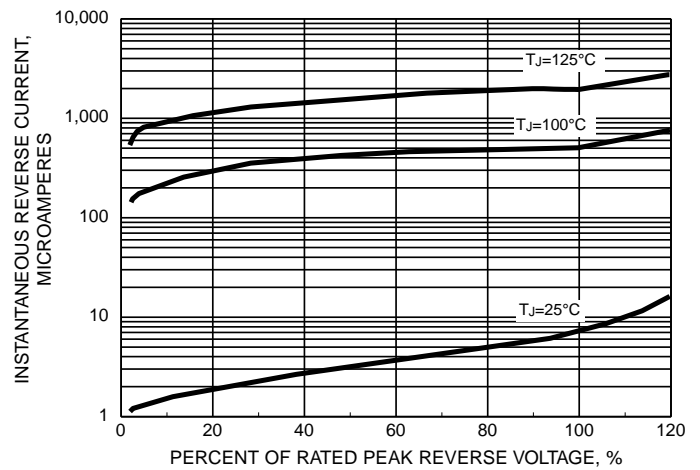

FIG. 5 - TYPICAL JUNCTION CAPACITANCE

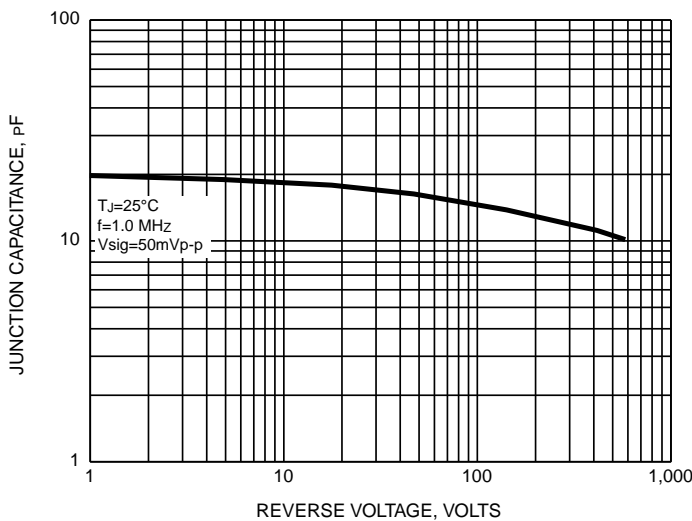

FIG. 6 - REVERSE SWITCHING CHARACTERISTICS

